



Relationships between riverine and terrestrial dissolved organic carbon: Concentration, radiocarbon signature, specific UV absorbance



Edward Tipping^{a,*}, Jessica L. Elias^{a,1}, Patrick O. Keenan^a, Rachel C. Helliwell^b, Nikolai Pedentchouk^{c,d}, Richard J. Cooper^c, Sarah Buckingham^e, Egil Gjessing^f, Philippa Ascough^g, Charlotte L. Bryant^g, Mark H. Garnett^g

^a UK Centre for Ecology and Hydrology, Lancaster Environment Centre, Lancaster LA1 4AP, UK

^b The James Hutton Institute, Craigiebuckler, Aberdeen AB15 8QH, Scotland, UK

^c School of Environmental Sciences, University of East Anglia, Norwich Research Park, Norwich NR4 7TJ, UK

^d Skolkovo Institute of Science and Technology, 30 Bld. 1 Bolshoy Boulevard, Moscow 121205, Russian Federation

^e Carbon Crop and Soils Group, Scotland's Rural College, Edinburgh EH9 3JG, UK

^f Faculty of Mathematics and Natural Sciences, University of Oslo, NO-0316 Oslo, Norway

^g NERC Radiocarbon Facility, East Kilbride G75 0QF, UK

HIGHLIGHTS

- Riverine [DOC], DO¹⁴C & SUVA were simulated from soil solution and groundwater data.
- High variability in riverine DOC mainly due to terrestrial source variations
- Riverine [DOC] c. 40% lower than expected from terrestrial data
- Terrestrial sources of riverine DOC depend on land cover.

GRAPHICAL ABSTRACT

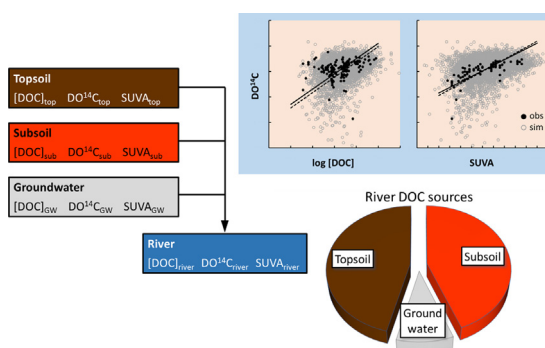

ARTICLE INFO

Article history:

Received 17 November 2021

Received in revised form 4 January 2022

Accepted 5 January 2022

Available online 11 January 2022

Editor: José Virgilio Cruz

Keywords:

Dissolved organic carbon

Groundwater

Radiocarbon

Rivers

Soil

Specific UV absorbance

ABSTRACT

The transfer of dissolved organic carbon (DOC) from land to watercourses plays a major role in the carbon cycle, and in the transport and fate of associated organic and inorganic contaminants. We investigated, at global scale, how the concentrations and properties of riverine DOC depend upon combinations of terrestrial source solutions. For topsoil, subsoil, groundwater and river solutions in different Köppen-Geiger climatic zones, we compiled published and new values of DOC concentration ([DOC]), radiocarbon signature (DO¹⁴C), and specific UV absorbance (SUVA). The average value of each DOC variable decreased significantly in magnitude from topsoil to subsoil to groundwater, permitting the terrestrial sources to be distinguished. We used the terrestrial data to simulate the riverine distributions of each variable, and also relationships between pairs of variables. To achieve good matches between observed and simulated data, it was necessary to optimise the distributions of water fractions contributed by each of the three terrestrial sources, and also to reduce the mean input terrestrial [DOC] values, to about 60% of the measured ones. One possible explanation for the required lowering of the modelled terrestrial [DOC] values might be unrepresentative sampling of terrestrial DOC, including dilution effects; another is the loss of DOC during riverine transport. High variations in simulated riverine DOC variables, which match observed data, are due predominantly to variations in source solution values, with a lesser contribution from the different combinations of source waters. On average, most DOC in rivers

* Corresponding author.

E-mail address: et@ceh.ac.uk (E. Tipping).

¹ Present address: Natural England, York, YO1 7PX, UK.

draining catchments with forest and/or grass-shrub land cover comes in similar amounts from topsoil and subsoil, with about 10% from groundwater. In rivers draining croplands, subsoil and groundwater solutions are the likely dominant DOC sources, while in wetland rivers most DOC is from topsoil.

1. Introduction

The transfer of dissolved organic carbon (DOC) from land to water-courses, and its subsequent advective transport, connects the terrestrial, freshwater and marine carbon cycles (Kindler et al., 2011; Camino-Serrano et al., 2014; Ward et al., 2017). Moreover, DOC plays a major role in the transport and fate of associated organic and inorganic contaminants (Aiken et al., 2011; Ripszám et al., 2015). A full understanding of the land-water transfers of DOC requires account to be taken of the amounts and types of DOC present in different terrestrial source solutions, and how those solutions combine to generate river water. In the study reported here we addressed this issue with a modelling analysis of soil solution, groundwater, and riverine DOC data, collected at the global scale. We employed not only DOC concentration, [DOC], but also two quality variables, radiocarbon content (DO^{14}C) and specific UV absorbance (SUVA; Weishaar et al., 2003).

Available evidence suggests that most terrestrial DOC is produced from litter and topsoil organic matter, as part of the turnover of soil organic carbon (Qualls and Haines, 1992; Neff and Asner, 2001; O'Donnell et al., 2010; Tipping and Rowe, 2019; Pschenyckyj et al., 2020), and may also come from root exudates. Its soil concentrations are controlled largely by mineralisation, adsorption and export in outflow. The latter includes percolation into the subsoil, where further mineralisation and adsorptive removal may take place (Michalzik et al., 2003; Kaiser and Kalbitz, 2012). The transfer of some of DOC to groundwater may also occur. Additional DOC may be generated by the turnover of solid-phase organic carbon in subsoil and groundwater. Data compilations have shown that [DOC] in soil solution is highest in the upper organic soil horizon, declining in the subsoil (Camino-Serrano et al., 2014; Langeveld et al., 2020), and being lower still in groundwaters (Regan et al., 2017). There is evidence that DOC characteristics change with depth in the soil/groundwater system, the material becoming less aromatic and light-absorbing, richer in N, and older (Qualls and Haines, 1991; Kaiser and Kalbitz, 2012). These properties can be monitored using optical absorbance, especially SUVA, and radiocarbon (e.g. Michalzik et al., 2003; Sanderman et al., 2008; Schulze et al., 2011). The optical properties depend upon the physicochemical characteristics of DOC, while its radiocarbon signature is related to terrestrial turnover rates and age (radioactive decay), and to the incorporation of "bomb" carbon resulting from atmospheric weapons testing in the mid-20th Century.

In line with the depth-dependence of DOC concentrations in the soil-groundwater system outlined above, the high riverine concentrations observed during stormflow are interpreted to indicate a significant contribution of topsoil DOC at high soil water saturation (Hornberger et al., 1994; Hagedorn et al., 2000; Hood et al., 2006; Wilson et al., 2016; Ward et al., 2017; Barnes et al., 2018), whereas at baseflow, riverine [DOC] is low and most may be from groundwater (Tiwari et al., 2014). For the same reasons, the highest SUVA and DO^{14}C values are observed at stormflow, and the lowest values at baseflow (Masiello and Druffel, 2001; Neff et al., 2006; Butman et al., 2012; Aiken et al., 2014; Marwick et al., 2015; Raymond and Spencer, 2015). Quantitative evidence for these relationships has largely been restricted to [DOC]. Studies include end-member mixing analyses for small catchments (Easthouse et al., 1992; Hagedorn et al., 2000; Van Verseveld et al., 2008; Van Gaalen et al., 2014); in the Hagedorn et al. and Van Verseveld et al. studies, both [DOC] and SUVA were used. Larger-scale modelling of terrestrial-river linkages was reported by Nakhavali et al. (2021) in an application of the JULES Earth System Model; these authors fitted soil solution [DOC] at different depths based on observations, and then used the results to predict riverine [DOC]. In a national-scale (United Kingdom) study, Bell et al. (2021) modelled [DOC] in UK rivers, by linking a riverine model to the outputs of layered terrestrial models operating at a grid scale of 5 km \times 5 km. The aim of the present

work was to establish more fully the relationships between terrestrial and riverine observations, by conducting a more comprehensive, wider analysis of DOC data, quantifying three different DOC variables each at a global scale. We extended the data for [DOC] in soil waters, based on the Langeveld et al. (2020) database, and added global compilations of data for DO^{14}C and SUVA, for three major Köppen-Geiger climatic zones (tropical, temperate, cold), covering forests, grassland and shrubland, wetlands and agricultural land.

We used the compiled data to characterise terrestrial solutions in terms of the means and standard deviations of each DOC variable. The means and standard deviations were then combined with fractional volumes of topsoil, subsoil and groundwater solutions, in an end-member mixing analysis, to simulate riverine variables. The fractional volumes were drawn from assumed or optimised distributions, to simulate distributions of the riverine variables, which were then compared with measured data, obtained by a major extension of the database created by Marwick et al. (2015). As well as comparing the observed and predicted distributions of each individual variable, we examined observed and predicted relationships between pairs of variables. Thus, we tested whether the available DOC data for rivers are consistent with mixtures of terrestrial solutions, and therefore whether the concentrations and properties of riverine DOC can be modelled reliably as a function of the DOC in the three source solutions (topsoil, subsoil, and groundwater).

2. Theory

We view the DOC in rivers as having up to three sources in the terrestrial system, namely topsoil solution, subsoil solution, and groundwater (Fig. 1). The DOC from each source has characteristic average values of [DOC], DO^{14}C and SUVA. It should be noted that in the present modelling effort, the three terrestrial solutions are regarded as starting points; we are not attempting to represent the processes that control the DOC concentrations and properties. It is assumed that measured DOC data for soil and groundwater solutions are representative of the DOC in water that enters the river. This is necessary if terrestrial solution data and riverine data are to be connected within a modelling framework that is simple enough to be applied at large scales. In effect, any net changes to DOC concentration or quality that might occur during passage through the soil and groundwater matrices, between the sampling points and the river channel, are neglected. If such changes are significant, then they should be reflected in differences between simulated and observed riverine DOC data.

If river waters are conservative mixtures of solutions from the three sources, we have

$$f_{\text{top}} + f_{\text{sub}} + f_{\text{GW}} = 1 \quad (1)$$

where f_{top} , f_{sub} and f_{GW} are the fractions of river water coming from topsoil, subsoil and groundwater respectively. Riverine [DOC] is given by.

$$[\text{DOC}]_{\text{river}} = f_{\text{top}} [\text{DOC}]_{\text{top}} + f_{\text{sub}} [\text{DOC}]_{\text{sub}} + f_{\text{GW}} [\text{DOC}]_{\text{GW}} \quad (2)$$

The riverine DO^{14}C value is determined by the amounts of DOC from each terrestrial source, together with their DO^{14}C values, according to the equation;

$$\text{DO}^{14}\text{C}_{\text{river}} = \frac{f_{\text{top}} \text{DO}^{14}\text{C}_{\text{top}} [\text{DOC}]_{\text{top}} + f_{\text{sub}} \text{DO}^{14}\text{C}_{\text{sub}} [\text{DOC}]_{\text{sub}} + f_{\text{GW}} \text{DO}^{14}\text{C}_{\text{GW}} [\text{DOC}]_{\text{GW}}}{[\text{DOC}]_{\text{river}}} \quad (3)$$

Over recent decades terrestrial DO^{14}C , in particular that in the topsoil, has been enriched with ^{14}C as a result of the incorporation of bomb carbon

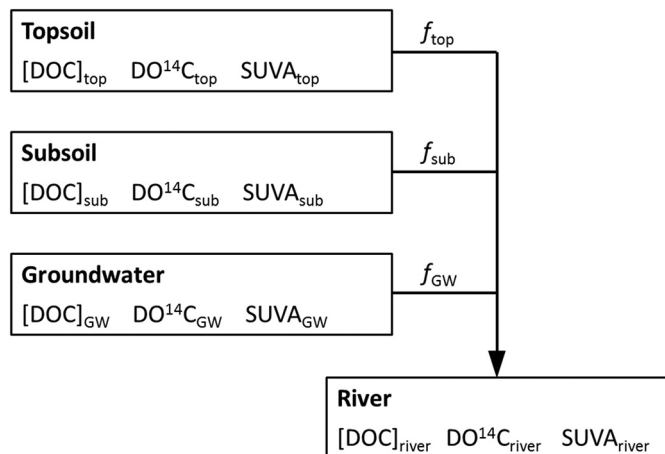

Fig. 1. Schematic of DOC terrestrial source solutions and their relationship to riverine DOC, for non-wetland soils. In wetlands, the subsoil solution does not contribute. The fractions of river water derived from the three terrestrial compartments are denoted by f_{top} , f_{sub} and f_{GW} .

into plant material and its decay products. Subsoil and groundwater DO¹⁴C may also have been affected by the bomb carbon inputs, but with more attenuated responses. Moreover, carbon in deeper soil and groundwater is older and therefore lower in radiocarbon. Therefore DO¹⁴C is expected to diminish in the sequence topsoil > subsoil > groundwater, but account must be taken of its temporal variation. The riverine SUVA value is given by

$$SUVA_{river} = \frac{f_{top} SUVA_{top} [DOC]_{top} + f_{sub} SUVA_{sub} [DOC]_{sub} + f_{GW} SUVA_{GW} [DOC]_{GW}}{[DOC]_{river}} \quad (4)$$

The above picture applies to oxic soils with several horizons. We view rivers draining wetland as comprising water from the oxic topsoil layer (acrotelm) plus groundwater; there is no subsoil source, because the subsoil is anoxic with negligible transmission of water.

Our analysis approach firstly involved establishing the means and distributions of the three variables [DOC], DO¹⁴C and SUVA in terrestrial source solutions. From the studies mentioned in the Introduction, it was anticipated that the results would show the three variables to differ significantly among the source solutions, the average value of each declining from topsoil to subsoil to groundwater. The second step was to compare distributions of observed riverine [DOC], DO¹⁴C and SUVA values with simulated results, which were obtained by combining values of the terrestrial source values, sampled randomly from their means and standard deviations, with assumed or optimised distributions of f_{top} , f_{sub} and f_{GW} . Comparisons of distributions were necessary because we did not know the values of f_{top} , f_{sub} and f_{GW} for individual riverine water samples, and therefore we could not solve Eqs. (1) to (4) for individual cases. Thirdly, if the average values of the terrestrial source DOC variables do indeed decline from topsoil to subsoil to groundwater, then from Eqs. (2), (3) and (4), pairs of riverine values, i.e. [DOC] and DO¹⁴C, [DOC] and SUVA, SUVA and DO¹⁴C, should be positively correlated.

3. Methods

3.1. Literature data

We compiled published data for [DOC], DO¹⁴C and SUVA in soil solutions, groundwaters and rivers. For soils, the database of Langeveld et al. (2020) provided many of the [DOC] values. For rivers, the DO¹⁴C compilation of Marwick et al. (2015), which covered the period 1991–2012, was used as a starting point for [DOC] and DO¹⁴C. We found additional data for [DOC] and DO¹⁴C, and data for SUVA, by searching the literature. Where necessary, we used digitisation software (ENGAUGE [http://](http://markummittell.github.io/engauge-digitizer/)

markummittell.github.io/engauge-digitizer/) to extract data from graphically-presented results. We also made new measurements (Section 3.2). Topsoil water was taken to be that sampled at depths of up to 20 cm from the surface. For soils, we collected both time-averaged data and data for single samples. We accepted data obtained in the field with tension and tension-free lysimeters; according to Langeveld et al. (2020), soil [DOC] values obtained with these two broad classes of collector do not differ significantly. We rejected data from laboratory incubations. For river waters, we collected only data for individual samples, and we only used [DOC] data that were paired with either DO¹⁴C or SUVA or both. We ignored data for rivers flowing out of major lakes, and those draining degraded peatlands, since they could not be expected to be relevant to the ideas about terrestrial-riverine relationships outlined in Section 2. It was not generally possible to classify river samples according to discharge, or relative discharge, at the time of sampling.

We used SUVA values (L mg⁻¹ m⁻¹) as reported, with no attempt to make corrections for the presence of chromophores other than organic matter, of which iron (Weishaar et al., 2003; Austnes et al., 2010; Poulin et al., 2014) and nitrate (Weishaar et al., 2003) are the prime examples. If present in sufficient amounts, both can make SUVA unusually high. Correction was not possible in view of the general lack of information about other chromophores in the field samples on which measurements had been made. By not making corrections, we essentially assumed that the effects of these other chromophores were similar in both terrestrial and riverine samples. The general absence of pH data for riverine DOC samples meant that we also could not correct the data for pH, although this is a fairly minor effect (Weishaar et al., 2003). Values of SUVA mostly referred to a wavelength of 254 nm; in the relatively few cases where they were reported for other wavelengths, the DOC absorbance model of Carter et al. (2012) was used to estimate the 254 nm values.

The data were assigned to climatic zones following the Köppen-Geiger system based on results reported by Peel et al. (2007) and Beck et al. (2013); these were tropical (A), temperate (C), cold but south of the Arctic (D), and Arctic (>65 °N). They were also classified in terms of broad land cover types; cropland, forest, grass-shrub, pasture (intensive), and wetland.

3.2. New measurements of DO¹⁴C

Sampling of river waters from the UK during 2013–2015 was carried out by researchers from the UK Centre for Ecology & Hydrology (UKCEH), Lancaster, the James Hutton Institute (JHI), Aberdeen, and the University of East Anglia (UEA), Norwich. We also report soil solution and riverine DO¹⁴C data obtained from the PROTOS project (Mulder et al., 2000) and two PhD theses (Scott, 1998; Buckingham, 2008); none of these data have so far appeared in the primary literature. Radiocarbon analyses were conducted at the Natural Environment Research Council Radiocarbon Facility at East Kilbride, Scotland; details are given in Supplementary information. We used percent modern absolute (pMC), rather than Δ¹⁴C, as the ¹⁴C unit for the present analysis, in order to avoid negative values that would complicate data fitting; our pMC values can be converted to Δ¹⁴C values from the formula Δ¹⁴C = (pMC – 100) / 10.

3.3. Data organisation

The final data sets used for analysis comprised the literature data plus the new measurements reported here. For soil solutions (Table S1), we averaged data for single samples collected at different times from the same site, and combined these with published values that had already been averaged. Where groundwater samples (Table S1) had been taken from several points within a single aquifer, we took simple averages of the measured values. Temporal trends in the topsoil solution DO¹⁴C data (Fig. S2) show a significant decline over the entire sampling period (1989–2015). However, the values level off from around 2000, and there is no significant decline (linear regression, $p > 0.05$) between 2001 and 2015, so we restricted the main analysis to values for this period. For subsoils and groundwaters there were no significant temporal trends in DO¹⁴C, and so we used all

the available data, which covered the time-periods 1989–2015 (subsoils) and 1973–2008 (groundwaters). The terrestrial solution data used in the analysis are given, divided according to climate zone and land cover type, in Table 1. Geographical locations of all the sampling points and of the used sampling points are shown in Fig. S1. The four terrestrial sites falling into zone B (arid), were included in the C zone. There were no terrestrial data for the Arctic region.

For rivers (Table S2) there were 1663 [DOC] data, 1281 DO¹⁴C data and 1081 SUVA data. Of these, 86 values for [DOC] and 101 for DO¹⁴C are reported for the first time in the present work. The riverine DO¹⁴C data (Fig. S3) show a significant decline over the period 1968–2015, i.e. after the bomb peak, but as with the topsoil solutions, there is no significant variation (linear regression, $p > 0.05$) between 2001 and 2015, and so again we restricted the main analysis to values for this period. The 12 riverine sites falling into zone B (arid), were included in the C zone. River catchment land covers were classified as cropland, forest, grass-shrub, mixed forest and grass-shrub, mixed including agricultural and/or urban, and wetland. Rivers were classified as short (<100 km), medium (100–500 km) and long (>500 km). The riverine data used in the analysis are given, divided according to climate zone and catchment type, in Table 2. Geographical locations of all the sampling points, and of the used sampling points, are shown in Fig. S1.

We have no reason to suppose that the sampling of soil solutions was biased. However, we estimate that in about half of the riverine studies, predominantly those in zones C and D, samples were taken to investigate DOC behaviour during flow events, or seasonal effects, or they were sampled in order to capture DOC data for a range of different flow conditions. Therefore these riverine data are likely to be biased towards higher discharges, and therefore would not represent the results that would be obtained by regular temporal sampling.

3.4. Data analysis

The analyses were conducted with Microsoft Excel, including the calculation of means and standard deviations, linear regression, and the performance of t -tests. All logarithms were to the base 10. Tests for normality were made using Q-Q plots to compare the distributions of measured values and, in the case of regressions with measured values, residuals, with expected normal distributions. Slopes and intercepts of bivariate plots of paired variables (DO¹⁴C vs log [DOC], SUVA vs log [DOC], DO¹⁴C vs

Table 1

Terrestrial solution data for Köppen-Geiger (K-G) zones A, C and D and for cropland (C), forest (F), grass-shrub (GS), pasture (P) and wetland (W). The values are averages of averaged data for each sampling site. All distributions are normal, except where there are very few data ($n < 8$), SD = standard deviation. Topsoil DO¹⁴C values refer to samples taken in 2001–2015 only. Units: [DOC] mg L⁻¹, DO¹⁴C percent modern carbon absolute (pMC), SUVA L mg⁻¹ m⁻¹.

	Solution	Land cover	K-G zone	<i>n</i>	Mean	SD
log [DOC]	Topsoil	F GS	A	34	1.08	0.34
			C	56	1.33	0.32
			D	129	1.45	0.36
		P	A,C,D	6	1.08	0.41
			A,C,D	40	1.38	0.31
			C,D	6	0.95	0.28
	Subsoil	F GS	A	49	0.57	0.42
			C	83	0.80	0.51
			D	112	0.83	0.38
		P	A,C,D	11	0.77	0.41
			A,C,D	28	0.22	0.39
			C,D	9	110.0	3.2
DO ¹⁴ C	Topsoil	F GS	C	2	112.6	0.3
			C,D	16	100.8	5.8
			All	11	54.4	29.4
	Subsoil	F GS	A,C,D	11	54.4	29.4
			C,D	8	3.81	0.65
			A,C,D	9	3.47	1.07
SUVA	Topsoil	F GS	D	1	1.19	
			A,C,D	11	2.50	0.67
			All	14	1.63	0.84
	Subsoil	F GS	A,C,D	11	2.50	0.67
			D	1	1.19	
			All	14	1.63	0.84

Table 2

Observed and optimised means and standard deviations (SD) for river samples. Units: [DOC] mg L⁻¹, DO¹⁴C percent modern carbon absolute (pMC), SUVA L mg⁻¹ m⁻¹.

Zone	Variable	<i>n</i>	Observed		Optimised	
			Mean	SD	Mean	SD
Forest and/or grass-shrub						
A	log [DOC]	134	0.574	0.332	0.552	0.291
	DO ¹⁴ C	55	101.6	9.8	99.5	10.6
	SUVA	85	3.23	0.69	3.01	0.67
C	log [DOC]	376	0.686	0.319	0.781	0.324
	DO ¹⁴ C	207	100.3	7.9	101.7	8.6
	SUVA	290	3.45	1.02	3.08	0.67
D	log [DOC]	366	0.748	0.390	0.835	0.307
	DO ¹⁴ C	192	99.2	8.8	102.5	8.0
	SUVA	187	3.56	0.91	3.15	0.66
Forest and/or grass-shrub, Arctic						
	log [DOC]	212	0.844	0.306	0.947	0.312
	DO ¹⁴ C	234	103.2	5.3	103.3	5.3
	SUVA	215	2.98	0.69	2.92	0.65
Cropland						
A,C,D	log [DOC]	109	0.391	0.203		
A,C,D	DO ¹⁴ C	49	87.8	10.9		
A,C,D	SUVA	62	1.89	0.86		
Mixed land cover with agricultural and/or urban areas						
C	log [DOC]	59	0.576	0.297		
C	DO ¹⁴ C	75	97.8	9.7		
C	SUVA	16	2.76	0.53		
D	log [DOC]	108	0.652	0.305		
D	DO ¹⁴ C	122	95.1	9.3		
D	SUVA	35	3.03	0.42		
Wetlands						
A,C,D	log [DOC]	273	1.26	0.27	1.26	0.33
A,C,D	DO ¹⁴ C	132	107.8	8.8	107.2	7.4
A,C,D	SUVA	191	4.79	0.71	3.38	1.05

SUVA) were calculated with standard major axis (SMA) and ranged major axis (RMA) regressions; these are appropriate because there is variability in both variables (Legendre and Legendre, 2012). For fitting, we used SMA regression because the slope and intercept are readily calculated from the means and standard deviations of the two variables. However, SMA does not permit the significance of the regression (p value) to be estimated (Legendre and Legendre, 2012), therefore we gauged the significance of the relationships using RMA, calculated with the R library program lmodel2 (R Core Team, 2017).

The first step in simulating the DOC composition of a river water sample was to sample randomly from normal or log-normal distributions of [DOC], DO¹⁴C and SUVA for each of the terrestrial source solutions (topsoil, subsoil, groundwater). The second was to obtain a set of f_{top} , f_{sub} and f_{GW} values, i.e. the fractions of river water from each terrestrial source solution. A volume of water, in the range from zero to one arbitrary volume unit, from each source was randomly selected (V_{top} , V_{sub} , V_{GW}). Each volume was then multiplied by a factor (k_{top} , k_{sub} , k_{GW}) characterising the relative outputs from the three sources. The total water volume is given by

$$V_{tot} = k_{top} V_{top} + k_{sub} V_{sub} + k_{GW} V_{GW} \quad (5)$$

and the fractions of water from each source are given by

$$f_{top} = k_{top} V_{top} / V_{tot} \quad f_{sub} = k_{sub} V_{sub} / V_{tot} \quad f_{GW} = k_{GW} V_{GW} / V_{tot} \quad (6)$$

Thirdly, the means and standard deviations of log [DOC], DO¹⁴C and SUVA from each terrestrial source were combined with f_{top} , f_{sub} and f_{GW} using Eqs. (2), (3) and (4) to obtain simulated riverine values of log [DOC], DO¹⁴C and SUVA. This procedure was repeated 5000 times to create a distribution of each riverine variable. For river catchments with forest, grass-shrub, and mixed land covers, the f_{top} , f_{sub} and f_{GW} values were varied

by adjusting k_{top} and k_{sub} , with k_{GW} held at a constant value (1.00). For wetland, k_{sub} was set to zero, k_{GW} was set to 1.00, and k_{top} was adjusted.

Data analysis was performed by adjustment of k_{top} and/or k_{sub} , and up to three parameters that modified the mean values of the terrestrial source variables. These were $\Delta \log [\text{DOC}]$, an offset for log [DOC] values, $f_{DO^{14}C}$ a factor to modify the $\text{DO}^{14}C$ means, and f_{SUVA} a factor to modify the SUVA means. The same value of each was applied to all the mean values, i.e. for topsoil, subsoil and groundwater.

To evaluate model outputs, we compared the observed and simulated means and standard deviations of each variable, together with the slopes and intercepts of bivariate plots of paired variables. The maximum number of riverine variables (means, standard deviations, slopes, intercepts for three climate zones) was thus 36. This number was achieved for rivers draining forest and grass-shrub land covers, but for wetlands it was appreciably less. For data fitting, we used two objective functions. The first involved mean values and standard deviations,

$$OF1 = \sum \{ (x_{\text{mean,obs}} - x_{\text{mean,sim}}) / x_{\text{mean,obs}} \}^2 + \{ (x_{SD,obs} - x_{SD,sim}) / x_{SD,obs} \}^2 \quad (7)$$

where the summation is over all x-values, i.e. log [DOC], $\text{DO}^{14}C$, and SUVA. In the case of $\text{DO}^{14}C$, the observed values clustered around the standardised value of 100 pMC, making error terms for the mean values comparatively small, and therefore a weighting factor of 10 was applied. The second objective function was derived from SMA fits of bivariate relationships,

$$OF2 = \sum \{ (\text{slope}_{\text{obs}} - \text{slope}_{\text{sim}}) / \text{slope}_{\text{obs}} \}^2 + \{ (\text{intercept}_{\text{obs}} - \text{intercept}_{\text{sim}}) / \text{intercept}_{\text{obs}} \}^2 \quad (8)$$

where the summation is over the different pairs of variables. For both OF1 and OF2, the values were weighted according to the number of riverine observations. The overall objective function for minimisation was the sum of OF1 and OF2. Model performances were compared using the Akaike Information Criterion (AIC).

4. Results

4.1. Soils and groundwater

Data for soil and groundwater solutions were sub-divided according to broad Köppen-Geiger zones (A, C or D) and land-cover type. Since the primary goal of the analysis was to define terrestrial source solutions for analysing the riverine data, and in view of the relatively small numbers of data in some categories, we combined data as far as possible, to produce robustly-defined source solution values. The adopted source solution values (Table 1), were obtained as follows.

For a given Köppen-Geiger zone, the forest and grass-shrub topsoil [DOC] values were of similar magnitude, and so could be combined. The distributions of topsoil [DOC] values were best approximated as log-normal. The mean log [DOC] values for combined forest and grass-shrub topsoils increased significantly (t -tests, $p < 0.001$) in the order zone A < zone C < zone D, which follows other findings in the literature (Langeveld et al., 2020; Camino-Serrano et al., 2014; Liu et al., 2021). There were insufficient topsoil pasture or wetland [DOC] values to distinguish between climate zones, and so the data were combined. There were no topsoil data for cropland.

The subsoil [DOC] data for both forest and grass-shrub were log-normally distributed, and did not differ significantly ($p > 0.05$). The average log [DOC] value for zone A subsoils was significantly ($p < 0.01$) less than the averages for zones C and D, which did not differ significantly ($p > 0.05$). The subsoil solution log [DOC] values were significantly ($p < 0.001$) less than the topsoil values. There were insufficient subsoil pasture or cropland [DOC] values to distinguish between climate zones, and so the data were combined. As explained in Section 2, wetland subsoil is not considered a source of DOC to rivers.

Owing to the sparsity of data for groundwaters, it was not possible to test for systematic differences in [DOC] among Köppen-Geiger zones or

among land-cover types. Therefore we combined all the groundwater [DOC] values into a single set, within which the data were log-normally distributed. The adopted source solution groundwater log [DOC] values were significantly ($p < 0.001$) less than both the topsoil and subsoil values.

There were insufficient $\text{DO}^{14}C$ data to allow distinctions between Köppen-Geiger zones, and so values for topsoil solutions (for the period 2001–2015; see Section 3.3) in zones A, C and D for forest and grass-shrub were combined, and the subsoil values for forest and grass-shrub were also combined. The distributions could be assumed normal. Groundwater $\text{DO}^{14}C$ values were combined, for all climatic zones and land-cover types; they were also normally distributed. The $\text{DO}^{14}C$ values decrease significantly ($p < 0.001$) from topsoil to subsoil, and both are greater ($p < 0.001$) than the average groundwater value. There were no $\text{DO}^{14}C$ data for pasture or cropland.

Values of SUVA for topsoil solutions in zones A, C and D for forest and grass-shrub were combined, as were the subsoil values. Topsoil wetland values were collected separately. Groundwater SUVA values were combined, for all climatic zones and land-cover types. All distributions were reasonably normal. The average SUVA values declined in the sequence topsoil > subsoil > groundwater and the differences were highly significant ($p < 0.001$). There were no SUVA data for pasture or cropland.

4.2. Analysis of riverine data

4.2.1. Rivers draining catchments with forest and/or grass-shrub land cover

The great majority (255 of 262) terrestrial source solution data for zone D were confined to latitudes below 60° N, and therefore might not relate directly to rivers draining Arctic (>65° N) catchments. Therefore we restricted our main analysis to rivers in zones A, C and D. We examined the data for evidence of differences in riverine DOC between catchments containing areas of wetland, and those that were wetland-free (cf. Spencer et al., 2013). We concluded that there was no evidence for such an effect (see explanatory text and data in SI), and therefore we combined data for all catchments with forest and/or grass-shrub land covers in zones A, C and D.

From the terrestrial solution data (Table 1), the conservative mixing model (Section 2) predicts that rivers draining catchments with forest and/or grass-shrub land covers would show increases in log [DOC] from climatic zone A to C to D. This was found to be the case, the average values being 0.574 ($n = 134$), 0.686 ($n = 376$) and 0.748 ($n = 366$) respectively; the mean for A differed highly significantly ($p < 0.001$) from those for C and D, while C was lower than D at $p < 0.05$. As found for the terrestrial solutions, no trends across climate zones in $\text{DO}^{14}C$ and SUVA were evident.

The main aim of the data analysis was to obtain the best matches between observed and simulated riverine log [DOC], $\text{DO}^{14}C$ and SUVA average values and standard deviations, and the slopes and intercepts of SMA regression plots, as judged by the value of the combined objective function (Eqs. (7) and (8)). To achieve this, we optimised the values of k_{top} and k_{sub} (Eqs. (5) and (6)), and if necessary one or more of the modifiers ($\Delta \log [\text{DOC}]$, $f_{DO^{14}C}$ and f_{SUVA}) of the terrestrial solution DOC variables. For simplicity, we assumed the distribution of f_{top} , f_{sub} and f_{GW} values to be the same in each climatic zone.

In the first optimisation, only k_{top} and k_{sub} were adjusted, and this resulted in fair agreements between predicted and measured values for $\text{DO}^{14}C$, all standard deviations, and the slopes and intercepts of bivariate plots. But the predicted values of log [DOC] were markedly too high, while those of SUVA were too low. The latter inadequacies were largely rectified by optimising $\Delta \log [\text{DOC}]$ as well as k_{top} and k_{sub} , but a further attempt with adjustment of k_{top} , k_{sub} , $\Delta \log [\text{DOC}]$ and f_{SUVA} did not produce a significant improvement in the objective function, as judged by AIC. A value of -0.225 was obtained for $\Delta \log [\text{DOC}]$, and the derived values of f_{top} , f_{sub} and f_{GW} were 0.246, 0.469 and 0.285 respectively; the simulated distributions are shown in Fig. 2. The calculated values obtained after optimisation of k_{top} , k_{sub} and $\Delta \log [\text{DOC}]$ are compared with observations in Tables 2 and 3, and Figs. 3 and 4.

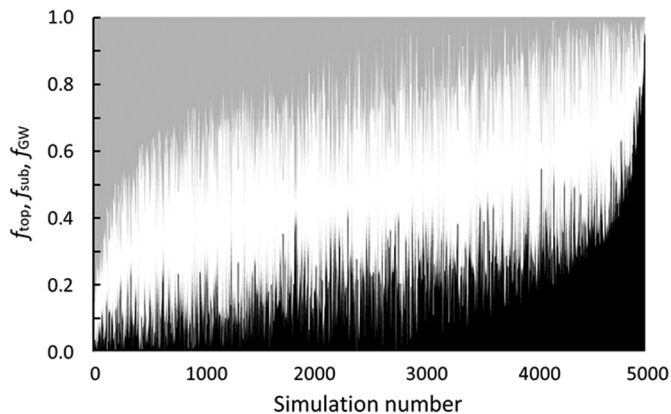

Fig. 2. Simulated distributions of f_{top} (black), f_{sub} (white) and f_{GW} (grey) for rivers draining forest and/or grass-shrub. The 5000 simulated river waters are ordered from minimum f_{top} /maximum f_{GW} to maximum f_{top} /minimum f_{GW} .

Our simulations gave standard deviations in agreement with the observed ones (Table 2). We used the optimised model to distinguish the contributions to the variations in riverine values of (a) terrestrial source solution variation, and (b) variations in f_{top} , f_{sub} and f_{GW} values. We set the standard deviations of the terrestrial source variables to zero, and reran the model. This reduced the overall average of simulated to observed riverine standard deviations from 0.90 to 0.43, which means that 77% of the variance in the calculated riverine values comes from variability in the terrestrial source variables, and 23% from variations in the riverine compositions (f_{top} , f_{sub} , f_{GW}).

We performed a separate analysis for the Arctic riverine data, assuming that the means and standard deviations of the source solution variables were the same as those for zone D, and with adjustment of k_{top} , k_{sub} and $\Delta \log [\text{DOC}]$. The best $\Delta \log [\text{DOC}]$ value was -0.056 , and the average values of f_{top} , f_{sub} and f_{GW} were 0.124, 0.820 and 0.056; the simulated distributions of f_{top} , f_{sub} and f_{GW} are shown in Fig. S4. Distributions of observed

Table 3

SMA regression results for DOC variables in rivers draining forest and grass-shrub ecosystems, and their mixtures, for different Köppen-Geiger zones. Units: [DOC] mg L^{-1} , DO^{14}C pMC, SUVA $\text{L mg}^{-1} \text{m}^{-1}$. Key: n number of data, p probability of significance of observed regression (RMA), m regression slope, c regression intercept. All the simulated regressions are significant at $p < 0.001$, and all relationships were normal, as judged by Q-Q plots (Table S4). See Figs. 4, 5, S7, S8 for plotted data.

Zone	x	y	n	p	Observed		Simulated	
					m	c	m	c
Forest and/or grass-shrub								
A	log [DOC]	DO^{14}C	52	<0.05	26.0	91.3	36.5	79.3
A	log [DOC]	SUVA	85	<0.001	2.20	1.85	2.31	1.74
A	SUVA	DO^{14}C	15	<0.01	16.5	55.7	15.8	51.8
C	log [DOC]	DO^{14}C	159	<0.01	23.9	86.0	26.4	81.0
C	log [DOC]	SUVA	290	<0.001	3.41	1.09	2.06	1.48
C	SUVA	DO^{14}C	87	<0.001	8.68	74.5	12.8	62.1
D	log [DOC]	DO^{14}C	148	<0.001	27.9	81.1	26.1	80.8
D	log [DOC]	SUVA	187	<0.001	2.04	1.90	2.16	1.35
D	SUVA	DO^{14}C	46	<0.001	12.1	64.4	17.6	49.7
Forest and/or grass-shrub Arctic								
	log [DOC]	DO^{14}C	208	<0.001	17.2	88.5	17.0	87.2
	log [DOC]	SUVA	191	<0.001	2.37	0.88	2.10	0.93
	SUVA	DO^{14}C	215	<0.001	7.8	80.8	8.1	79.6
Mixed land cover with agricultural and/or urban areas								
C	log [DOC]	DO^{14}C	88	<0.001	36.1	72.2		
D	log [DOC]	DO^{14}C	107	<0.001	31.5	74.0		
Wetland								
ACD	log [DOC]	DO^{14}C	86	<0.001	18.8	82.6	23.7	79.1

and simulated DOC variables, and bivariate relationships, are shown in Fig. 5, and the results are summarised in Tables 2 and 3.

A possible explanation for the lower-than-expected riverine log [DOC] values is decomposition and/or mineralisation of the organic matter during its riverine transport. This could mean that longer rivers tend to have lower log [DOC] values than shorter ones. We tested this by dividing up the observations according to river length for the forest, grass-shrub and mixed catchments, and comparing the distributions of log [DOC]. The distributions show no obvious or consistent differences (Fig. S5), and so there is no evidence in this data set that river length influences the results.

4.2.2. Rivers draining cropland and mixed catchments

There were few data for rivers draining croplands, and so we combined values across zones A, C and D. Moreover, solution data for croplands were restricted to a few observations of log [DOC] for subsoils (Table 1). Therefore we could not conduct a full modelling analysis as described in Section 3.4. To gain insight into the transfer of DOC from croplands to rivers, we therefore simply considered the means and distributions of the DOC variables. The average values of log [DOC], DO^{14}C and SUVA are each significantly ($p < 0.001$) lower than those for rivers draining catchments with forest and/or grass-shrub land cover (Table 2), and their distributions fall consistently below the forest and/or grass-shrub values (Fig. S6).

Appreciable riverine data were available for rivers draining mixed catchments, i.e. those containing forest and/or grass-shrub land cover and also agricultural and/or urban areas. The complexity of these mixed catchments means that a full modelling analysis as described in Section 3.4 would only be possible with quite strong assumptions about terrestrial source DOC in the agricultural and urban soils. Therefore, as for cropland rivers, it is safer simply to consider the means and distributions of the riverine DOC variables. The mean values are all significantly lower than those for pure forest and/or grass-shrub (Table 2); for log [DOC], DO^{14}C and SUVA in zone C, $p < 0.05$, $p < 0.05$ and $p < 0.001$ respectively; for zone D, $p < 0.001$, $p < 0.001$ and $p < 0.01$ respectively. However, the differences are small in comparison to those for cropland rivers, and the distributions are shifted only modestly from the forest and/or grass-shrub distributions (Fig. S7). For these mixed catchments, two significant bivariate relationships were found, both for DO^{14}C vs log [DOC]; see Table 3 and Fig. S7.

4.2.3. Rivers draining wetlands

We combined all the wetland riverine data for the three climatic zones, to obtain means and standard deviations for each DOC variable and one significant bivariate relationship, DO^{14}C vs log [DOC] (Table 3); the relationship between SUVA and [DOC] ($n = 190$) was not significant. We used the observed terrestrial solution data, also combined over climatic zones (Table 1) to perform the analysis, optimising k_{top} and $\Delta \log [\text{DOC}]$. For DO^{14}C we used the forest and grass-shrub values, since these were similar to the two wetland values (Table 1) but had a more realistic standard deviation. The optimised value of $\Delta \log [\text{DOC}]$ was 0.000, and the average values of f_{top} and f_{GW} were 0.772 and 0.228 ($f_{sub} = \text{zero}$; Section 3.4); the simulated distributions are given in Fig. S4. Simulated and observed values of the DOC variables are compared in Tables 2 and 3 and in Fig. S8. Note that there is a large discrepancy between the simulated and observed SUVA values.

4.2.4. Contributions of terrestrial sources to riverine DOC

We estimated the average compositions of riverine DOC, in terms of the separate contributions from topsoil, subsoil and groundwater, by averaging outputs from the fitting simulations. Results for rivers draining different catchment land covers are shown in Table 4.

5. Discussion

The summary data in Table 1 confirm the expectations summarised in the Introduction that terrestrial DOC becomes less concentrated, and its ^{14}C signature and SUVA value decrease, from topsoil to subsoil to groundwater. Our compiled data provide a robust quantification of the means

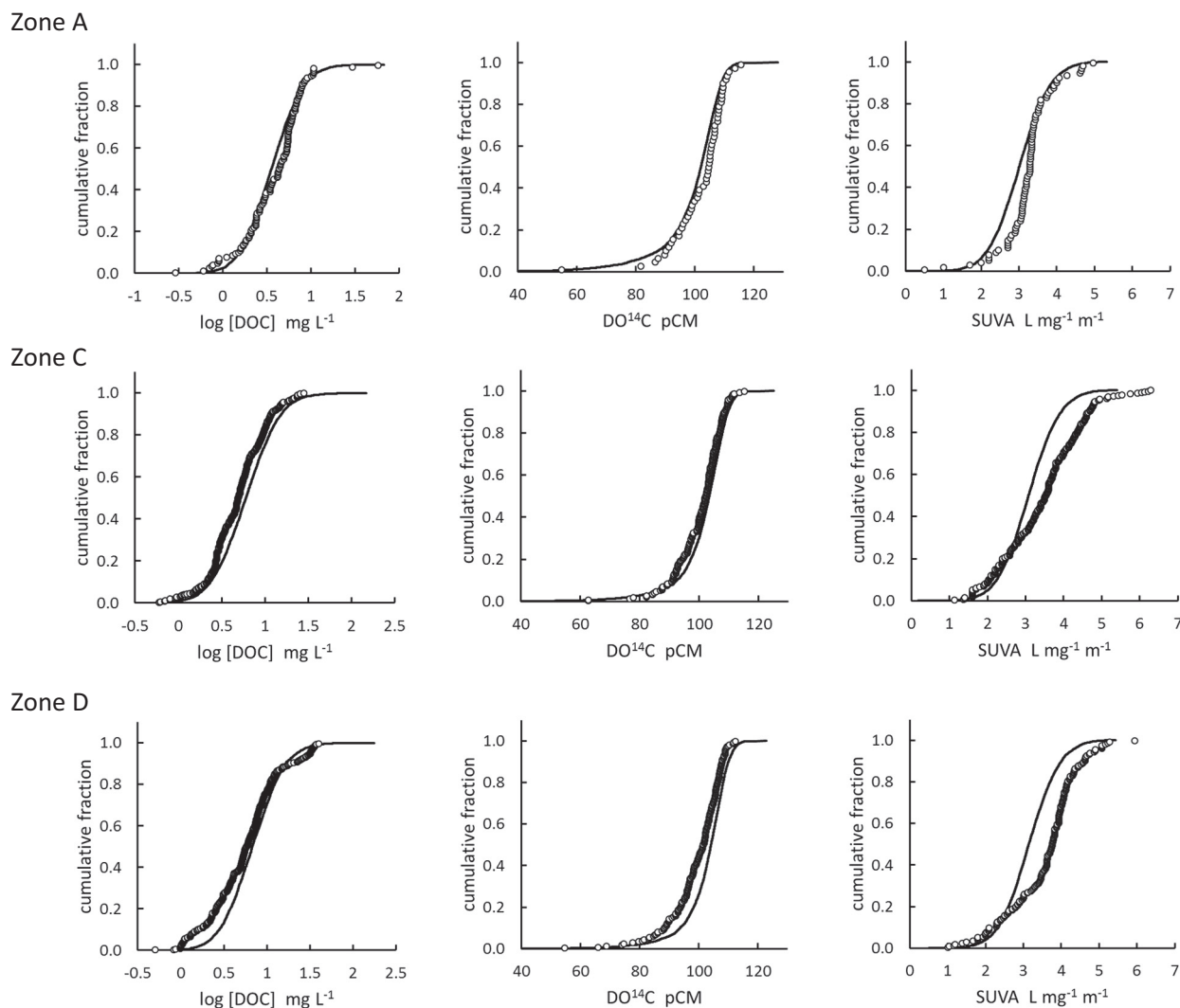

Fig. 3. Cumulative distribution functions for DOC variables in rivers draining forest and/or grass-shrub, for Köppen-Geiger zones A, C and D (non-Arctic). The points are observations, the lines are simulated with an adjustment, using $\Delta \log [\text{DOC}]$, of terrestrial source solution mean $\log [\text{DOC}]$ values, and with an optimised distribution of the contributing fractions (f_{top} , f_{sub} , f_{GW}) of terrestrial solutions.

and standard deviations for soils in climate zones A, C and D where the land cover is forest and/or grass-shrub, and yield useful information about soils beneath other land covers. There are also appreciable data for groundwater DOC. It has therefore been possible to perform analyses of riverine data based on terrestrial source solutions. After adjustment of parameters governing the mixing of source solutions (k_{top} , k_{sub}), and of the $\Delta \log [\text{DOC}]$ offset to the mean $\log [\text{DOC}]$ values of the terrestrial source solutions, the optimised models reproduce quite well the distributions and bivariate relationships of the DOC data for rivers draining forest and/or grass-shrub land cover (Tables 2 and 3, Figs. 3–5, and for rivers draining wetlands (Tables 2 and 3, Fig. S8), except for SUVA (see below).

Relationships between pairs of riverine variables ($[\text{DOC}]$ and SUVA, $[\text{DOC}]$ and DO^{14}C , SUVA and DO^{14}C), have been widely reported (e.g. Neff et al., 2006; Butman et al., 2012; Aiken et al., 2014; Marwick et al., 2015; Lee et al., 2021), but direct quantitative links to terrestrial source solutions, as shown here, have not previously been demonstrated. Of the 22 instances of bivariate data occurring in our data set, 15 showed significant relationships (Table 3).

The standard deviations in the terrestrial solution values, observed and simulated, are relatively large (Table 2), indicating substantial ranges in DOC concentrations and properties, evidenced in the bivariate plots (Figs. 4, 5, S6–S8). As shown by the calculations for rivers draining forest and/or grass-shrub land covers (Section 4.2.1), variation in the riverine

DOC properties arises mostly from variations in the terrestrial source solutions, with a smaller effect from the relative contributions of the topsoil, subsoil and groundwater solutions to river water, i.e. the f_{top} , f_{sub} and f_{GW} values.

5.1. The $\log [\text{DOC}]$ offset, $\Delta \log [\text{DOC}]$

The $\Delta \log [\text{DOC}]$ value of -0.225 obtained for rivers draining forest and/or grass-shrub means that the riverine mean $[\text{DOC}]$ values were on average 60% of those expected from the terrestrial source values in Table 1. The Arctic $\Delta \log [\text{DOC}]$ value is near to zero (-0.056), based on assumed terrestrial $\log [\text{DOC}]$ values assumed to be the same as those for non-Arctic zone D. However, in view of the increasing trend in topsoil $\log [\text{DOC}]$ from zone A to zone C to non-Arctic zone D (Section 4.2.1), i.e. with decreasing temperature, it might be expected that the even colder topsoils of the Arctic would have higher $\log [\text{DOC}]$, and therefore that the true Arctic $\Delta \log [\text{DOC}]$ is more negative than -0.056 . If so, then the Arctic rivers too would show appreciably lower $[\text{DOC}]$ than expected from the terrestrial values.

The discrepancy between riverine and terrestrial $[\text{DOC}]$ may arise for two main reasons, unrepresentative soil solution values and losses of DOC during riverine transport. The former could arise simply from dilution by water that has had little or no contact with the soil, as assumed in several

Zone A

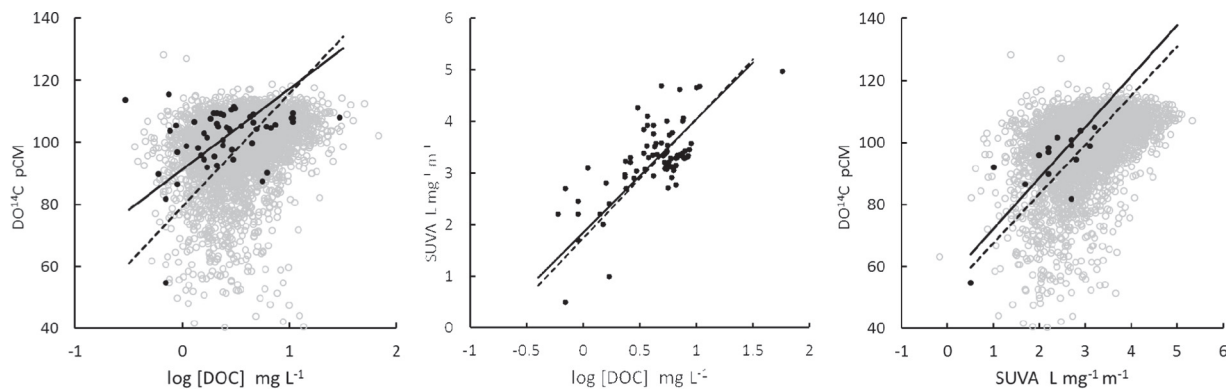

Zone C

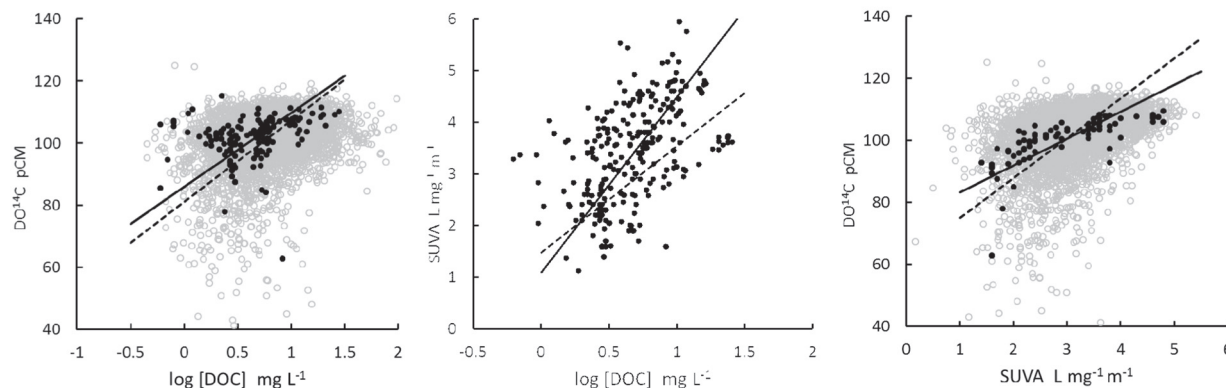

Zone D

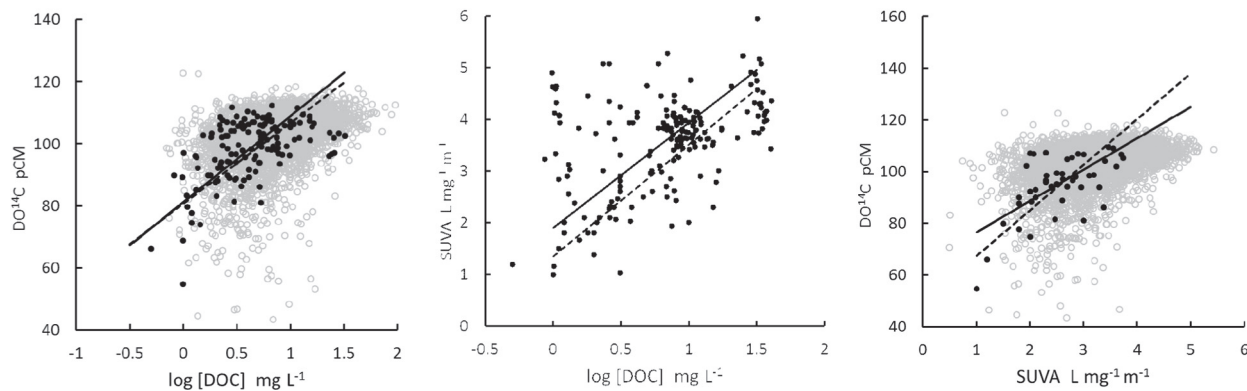

Fig. 4. Relationships between pairs of DOC variables in rivers draining forest and/or grass-shrub, for different Köppen-Geiger zones. The full lines are SMA regressions for the observations (filled symbols). The dashed lines are SMA regressions for simulations (open symbols), derived from the optimised terrestrial source solution values. Details of slopes and intercepts are given in Table 3. See Table S4 for normality test results.

hydrograph separation studies in headwater catchments (Bazemore et al., 1994; Hagedorn et al., 2000; Joerin et al., 2002; Van Verseveld et al., 2008; Van Gaelen et al., 2014). If such water escapes collection by lysimeters, the river water will have lower [DOC] than expected from soil water data. Another possibility is that the reported average values of [DOC] are biased towards low soil water flows, with relatively high [DOC], whereas flux-weighted [DOC] values would be more realistic; thus, from data published by Buckingham et al. (2008), the average flux-weighted [DOC] for 54 yearly collations at 21 varying sites was 91.5% (standard deviation 16.1%) of the simple mean value. It also has to be acknowledged that the simple three-box model employed here ignores the heterogeneity of soil

water, in particular preferential flow (Beven and Germann, 1982; Franklin et al., 2021). Finally, it may be that water transferring to rivers comes from parts of the catchment with different [DOC] levels than the average locations used for soil water sampling. If these sampling points are biased towards DOC that is relatively freshly produced, then significant losses of DOC during passage through the terrestrial system may occur. It has also been suggested that riparian zones are the dominant source of DOC to headwater streams in Swedish boreal forests (Ledesma et al., 2018).

Losses of terrigenous DOC during riverine transport may occur by a variety of mechanisms, notably photodegradation, microbial processing, flocculation and adsorption by mineral matter (Raymond and Spencer, 2015;

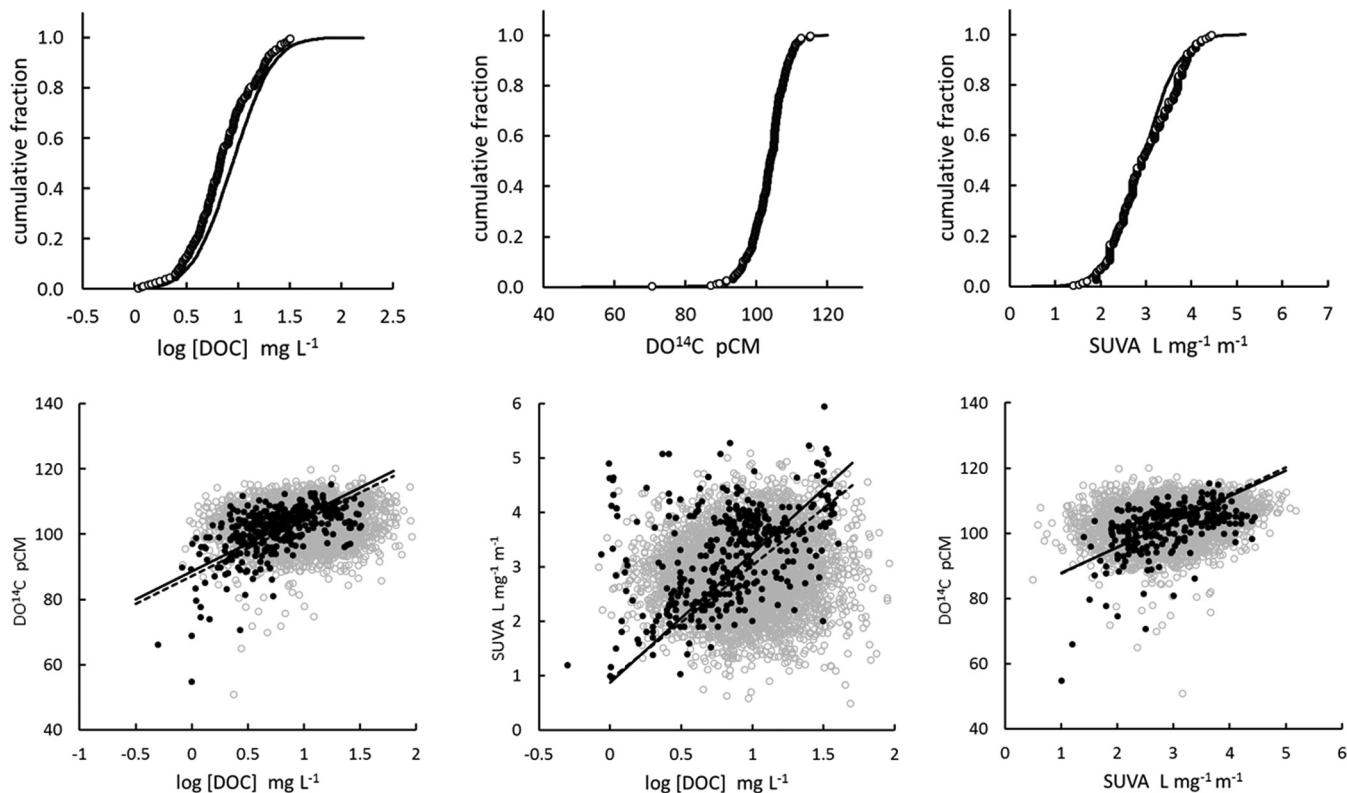

Fig. 5. Cumulative distribution functions, and bivariate plots, for DOC variables in rivers draining forest and/or grass-shrub in Arctic catchments. In the upper panels, the points are observations, the lines are simulated with an adjustment, using $\Delta \log [\text{DOC}]$, of terrestrial source solution mean $\log [\text{DOC}]$ values, and with an optimised distribution of the contributing fractions (f_{top} , f_{sub} , f_{GW}) of terrestrial solutions. In the lower panels, the full lines are SMA regressions for the observations (filled symbols). The dashed lines are SMA regressions for simulations (open symbols), derived from the optimised terrestrial source solution values. Details of slopes and intercepts are given in Table 3. See Table S4 for normality test results.

Anderson et al., 2019). For relatively small rivers, field evidence suggests that losses are minor. For example, Kothawala et al. (2015) reported negligible in-stream dissolved organic matter degradation in low-order boreal streams, Wollheim et al. (2015) estimated little removal of DOC in the rivers of a medium sized (400 km²) network in Massachusetts, USA, and Huntington et al. (2019) demonstrated conservative transport of DOC for the rivers of the state of Maine, USA. However, Mineau et al. (2016) combined measurements and modelling to estimate that 27–45% of terrestrial DOC input was lost during transport to the ocean in north-east US rivers. At larger scales, greater losses may occur; both Sanderman et al. (2009) and Williamson et al. (2021) make the point that the relatively quick passage of water through short rivers leaves less time for processing. By comparing DOC fluxes in small and large rivers, Lauerwald et al. (2012) estimated that, in the area of North America south of 60°N, 23% of DOC was lost during transport to the oceans. However, our analysis of [DOC] in rivers of different length represented in the present data set (Fig. S5) did not reveal any consistent differences. It should not be forgotten that DOC may also be generated within rivers, via photosynthesis within or adjacent to the river (Mayorga et al., 2005; Creed et al., 2015; Casas-Ruiz et al., 2017), by desorption of DOC from suspended sediment (Masiello

and Druffel, 2001), and in anthropogenic inputs including waste water, industrial effluents and agrochemicals in farmland runoff (Butman et al., 2012; Naden et al., 2016).

The loss of DOC during riverine transport was explored by quantitative mechanistic modelling with the UniDOM model (Anderson et al., 2019). Application of UniDOM to an idealised river of medium length in the UK with a water residence time of about one day, led to an estimate of a 10% loss of DOC during riverine transport, which is appreciably less than the c. 40% needed to resolve the discrepancy in our data. At lower flows UniDOM would predict greater proportional losses, perhaps resolving the discrepancy. The soil hydrological factors that lead to lower than measured [DOC] under conditions of high water saturation may dominate at high flows. It is noteworthy that DO¹⁴C and SUVA, and their bivariate relationships, are reasonably well-described without parameter adjustment which suggests that the factors involved in riverine losses apply similarly to DOC from different sources.

5.2. The values of f_{top} , f_{sub} and f_{GW} in forest and/or grass-shrub catchments

These are the fractions of river water contributed by the three terrestrial source waters, according to the simulations. We report both average values

Table 4

Average compositions of river water in terms of source solutions, based on 5000 simulations of river water in each case. The values of f_{top} , f_{sub} and f_{GW} are the average fractions of topsoil, subsoil, and groundwater solutions comprising the river water, while DOC_{top} , DOC_{sub} and DOC_{GW} are the average fractional contributions of topsoil, subsoil, and groundwater DOC to the river DOC. Values in brackets are standard deviations.

	Zone	f_{top}	f_{sub}	f_{GW}	DOC_{top}	DOC_{sub}	DOC_{GW}
Forest/grass-shrub	A	0.246	0.469	0.285	0.483 (0.280)	0.388 (0.270)	0.129 (0.152)
	C	0.246	0.469	0.285	0.508 (0.289)	0.406 (0.287)	0.086 (0.119)
	D	0.246	0.469	0.285	0.553 (0.281)	0.371 (0.268)	0.076 (0.107)
	Arctic	0.124	0.820	0.056	0.336 (0.271)	0.648 (0.275)	0.016 (0.036)
Wetland	A-C-D	0.772	–	0.228	0.949 (0.108)	–	0.051 (0.108)

(Section 4.2) and the full simulations (Figs. 2, S4). It is important to recognise that the results can only be assumed to apply to the present riverine data set, because, as explained in Section 3.3, the values for the observations are likely biased by sampling effort and interest in high flow events. Seasonal variability may also contribute. Thus, although our riverine sites can reasonably be considered representative, this does not apply to the flow conditions. It is probable that, had the rivers draining forest and/or grass-shrub catchments in zones A, C and D (non-Arctic) been sampled truly randomly over time, the groundwater source would be more prominent, the average f_{top} lower, and the topsoil DOC contribution therefore lower than these estimates. The results for the Arctic and the mixed sites are more representative and this may explain why their average f_{top} values are smaller.

The averaged sources of terrestrial DOC to the riverine pool, derived from the simulation results (Table 4), suggest that topsoil DOC exceeds subsoil DOC in rivers draining catchments with forest and/or grass-shrub land cover in zones A, C and D. However the likely bias towards f_{top} in these rivers, as discussed above, means that the differences are unlikely to be representative. The results for Arctic rivers, for which there is likely less bias in the f_{top} , f_{sub} and f_{GW} values, show a preponderance of subsoil DOC. Precise relationships among the sources cannot be derived, but it is safe to say that for rivers draining the forest and/or grass-shrub land covers the topsoil and subsoil sources contribute similarly, on average, to the riverine DOC, and that the groundwater source is relatively minor, of the order of 10% (Table 4). Whereas these average values provide a broad picture, relevant to the total transport of DOC to the oceans for example, it should be remembered that river waters are highly heterogeneous with respect to DOC sources, as indicated by the relatively large standard deviations in Table 4. A final point is that the values of f_{top} , f_{sub} and f_{GW} refer to instantaneous river concentrations, not fluxes. The tendency for topsoil water to make a greater contribution to discharge at high flows (see Introduction) means that with respect to overall riverine DOC flux the predominant DOC source will be topsoil.

5.3. Rivers draining croplands

The results in Table 2 and Fig. S6 show marked differences in DOC between rivers draining croplands and those draining forest and/or grass shrub land cover. In cropland rivers, DOC concentrations are lower, the material contains less radiocarbon, and it has low SUVA; the DOC is akin to that in subsoils and groundwater solutions. Under the assumption that cropland soil solutions have similar log [DOC], DO^{14}C and SUVA values to those under forest and/or grass shrub, which is supported to some extent by the few log [DOC] data for cropland subsoils (Table 1), it would be concluded from their DOC properties that the cropland rivers receive little or no water directly from topsoil. This would suggest that, instead of passing directly to the river, most of the water leaving topsoil enters the subsoil, where its DOC can be held up and modified (see Introduction). The diversion of water to deeper soil in this way would be consistent with the fact that most cropped terrestrial systems are generally well-drained, either naturally or as the result of engineering.

For mixed catchments, the averages and standard deviations of the DOC variables (Table 2) and bivariate regressions (Table 3, Fig. S7), are consistent with a predominance of DOC from natural land covers, modified somewhat by DOC from croplands and other strongly human-influenced land covers.

Low DO^{14}C values in rivers draining croplands, and other land highly influenced by humans, were reported by Butman et al. (2015), and interpreted to mean increased mobilisation of old carbon as a result of disturbance. According to our mixing model (Fig. 1), the principal mechanism of the disturbance is altered hydrology, which leads to the production of riverine DOC principally from subsoil and groundwater. The low values of log [DOC] found for rivers draining cropland (Table 2) suggest that the disturbance may actually result in lower riverine DOC fluxes, owing to the greater processing of DOC within the terrestrial system, compared to more natural land covers.

5.4. Rivers draining wetlands

For wetland rivers, the optimised value of $\Delta\log$ [DOC] is zero, indicating that river water behaves as a simple mixture of terrestrial sources. It therefore appears that the mean measured wetland [DOC] for topsoil is representative of the water passing into rivers, and there are insignificant losses of DOC during riverine transport. The latter might reflect the fact that all the wetland rivers in our database are short, which could mean that there is insufficient time for noticeable losses to occur. It is also possible that wetland DOC is relatively less susceptible to mineralisation.

A discrepancy with respect to wetland rivers is that, although the modelling worked satisfactorily for DO^{14}C (Tables 2 and 3, Fig. S8), the simulated average SUVA value was only $3.38 \text{ L mg}^{-1} \text{ m}^{-1}$ compared to the observed average of $4.79 \text{ L mg}^{-1} \text{ m}^{-1}$ (Table 2). This 30% shortfall might be attributed to the limited data, possibly unrepresentative, on which the average SUVA for wetland topsoils is based; our value comes from mean values for nine field sites, of which five, averaging $2.82 \text{ L mg}^{-1} \text{ m}^{-1}$, are for New Zealand peatlands (Moore and Clarkson, 2007). However, in the study of Austnes et al. (2010), samples from both the river and the source wetlands were taken, and the average SUVA values differed similarly to our overall averages, with means of $3.90 \text{ L mg}^{-1} \text{ m}^{-1}$ for the terrestrial source and $5.21 \text{ L mg}^{-1} \text{ m}^{-1}$ for the river. Austnes et al. (2010) considered that their riverine SUVA values were overestimated due to the presence of iron, which they estimated to contribute between 0.5 and $1.0 \text{ L mg}^{-1} \text{ m}^{-1}$ to measured SUVA. If this were widely the case, then it might explain the discrepancy that we observe, although this would entail the assumption that Fe is present at much lower concentrations in the topsoil solution, and has a different source to rivers than DOC. Additional data are needed to resolve this inconsistency. However, it does seem reasonable to suppose that topsoil DOC is easily the dominant source of DOC in wetland rivers (Table 4).

5.5. Implications for carbon cycle modelling

A major motivation for this work was to inform large-scale dynamic modelling efforts, aimed at simulating and predicting changes in the carbon cycle at regional and global scales. Our results provide some justification for modelling DOC transfers from land to freshwaters based on terrestrial source solutions (Fig. 1). However, they show that riverine DOC concentrations (and by implication, fluxes) would be overestimated if the terrestrial solution concentrations in the model were calibrated from measured values, as collected in Table S1. This approach was taken in modelling with JULES (Nakhavali et al., 2021), and average headwater [DOC] was indeed largely over-predicted for different regions across the USA.

As well as modelling concentrations and fluxes of DOC, quality variables are also useful for testing and constraining models. Values of SUVA provide insight into terrestrial sources and the susceptibility to photo-oxidation. Values of DO^{14}C also help with sourcing, and another use of DO^{14}C , in combination with SO^{14}C , is to provide information on organic matter turnover rates (see e.g. Michalzik et al., 2003; Tipping et al., 2012). A useful feature has been the ^{14}C enrichment of terrestrial organic carbon due to mid-20th Century weapons testing. This is seen in both terrestrial and riverine DOC (Figs. S1 and S2). However, the bomb pulse is now fading, and consequently the ^{14}C signatures of recently photosynthesised carbon are becoming indistinguishable from those of older carbon in the subsoil. Therefore the usefulness of DO^{14}C to relate DOC to bulk soil organic carbon turnover in the future is diminishing. However, the development and testing of dynamic carbon cycle models can continue to exploit the bomb carbon signal, using existing data sets such as those presented in Tables S1 and S2.

6. Conclusions

- For forest and grass-shrub land covers, measured data for three terrestrial sources of riverine DOC, namely topsoil solution, subsoil solution, and groundwater reveal significant differences in DOC concentration and in two characteristic properties, DO^{14}C and SUVA. The standard deviations

are relatively large, indicating substantial variability. Average topsoil [DOC] increases across Köppen-Geiger zones, in the order A (tropical) < C (temperate) < non-Arctic D (cold).

- Although there is strong evidence for changes in topsoil DO^{14}C and riverine DO^{14}C over recent decades, reflecting the uptake and release of bomb carbon, the rates of changes have lessened, and there was no significant time dependence over the period 2001–2015. Therefore the 2001–2015 data could be used for source identification.
- To match riverine observed and simulated log [DOC], DO^{14}C and SUVA, it was necessary to optimise the relative contributions of topsoil, subsoil and groundwater solutions to river water, and also to scale log [DOC] in the terrestrial source solutions. Satisfactory agreements between simulated and observed distributions of the three DOC variables, and between bivariate relationships, were achieved for rivers draining catchments with land covers of forest and/or grass-shrub. For wetlands, log [DOC] and DO^{14}C were well-matched, but simulated SUVA values were substantially too low.
- High variability in riverine DOC simulated variables, which matches observed data, is predominantly due to variability in source solution values, with a lesser contribution from the different combinations of source waters.
- The scaling of DOC means that the riverine values are lower than expected, by about 40%, for rivers draining catchments with land covers of forest and/or grass-shrub. This could be due to unrepresentative sampling of soil water, likely important at high soil water saturation, and to losses of DOC during riverine transport.
- On average, most DOC in rivers draining catchments with forest and/or grass-shrub land cover comes in similar amounts from topsoil and subsoil, with about 10% from groundwater. In rivers draining croplands, most DOC likely comes from subsoil and groundwater, while in wetland rivers most DOC is from topsoil.

Supplementary data to this article can be found online at <https://doi.org/10.1016/j.scitotenv.2022.153000>.

CRediT authorship contribution statement

Edward Tipping: Conceptualization, Methodology, Software, Formal analysis, Supervision, Funding acquisition, Writing – review & editing, Data curation. **Jessica L. Elias:** Conceptualization, Investigation, Writing – original draft, Writing – review & editing. **Patrick O. Keenan:** Investigation. **Rachel C. Helliwell:** Investigation, Methodology, Funding acquisition, Writing – review & editing. **Nikolai Pedentchouk:** Investigation, Methodology, Funding acquisition, Writing – review & editing. **Richard J. Cooper:** Investigation, Methodology, Visualization, Writing – review & editing. **Sarah Buckingham:** Investigation. **Egil Gjessing:** Investigation. **Philippa Ascough:** Investigation, Writing – review & editing. **Charlotte L. Bryant:** Investigation, Writing – review & editing. **Mark H. Garnett:** Investigation, Writing – review & editing.

Declaration of competing interest

The authors declare that they have no known competing financial interests or personal relationships that could have appeared to influence the work reported in this paper.

Acknowledgements

We thank J. Mulder (Norwegian University of Life Sciences) and N. Clarke (Norwegian Institute of Bioeconomy Research) and colleagues for help with sample collection at Birkenes, Norway, and A Pantou (National Oceanography Centre, University of Southampton) and EC Rowe (CEH Bangor) for help with sample collections from the Rivers Avon and Conwy. We are grateful to Brett A. Poulin (US Geological Survey) for providing archived samples of DOM. The research was partly funded by the UK Natural Environment Research Council Macronutrient Cycles Programme (LTLS project, Grant No. NE/J011533/1), and the Scottish Government. We

thank an anonymous reviewer for their thoughtful and constructive comments. This work is dedicated to the memory of George R. Aiken (US Geological Survey).

References

- Aiken, G.R., Hsu-Kim, H., Ryan, J.N., 2011. Influence of dissolved organic matter on the environmental fate of metals, nanoparticles, and colloids. *Environ. Sci. Technol.* 45, 3196–3201.
- Aiken, G.R., Spencer, R.G.M., Striegl, R.G., Schuster, P.F., Raymond, P.A., 2014. Influences of glacier melt and permafrost thaw on the age of dissolved organic carbon in the Yukon River basin. *Glob. Biogeochem. Cycl.* 28, 525–537.
- Anderson, T.R., Rowe, E.C., Polimene, L., Tipping, E., Evans, C.D., Barry, C.D.G., et al., 2019. Unified concepts for understanding and modelling turnover of dissolved organic matter from freshwaters to the ocean: the UniDOM model. *Biogeochemistry* 146, 105–123.
- Austnes, K., Evans, C.D., Eliot-Laize, C., Naden, P.S., Old, G.H., 2010. Effects of storm events on mobilisation and in-stream processing of dissolved organic matter (DOM) in a Welsh peatland catchment. *Biogeochemistry* 99, 157–173.
- Barnes, R.T., Butman, D.E., Wilson, H.F., Raymond, P.A., 2018. Riverine export of aged carbon driven by flow path depth and residence time. *Environ. Sci. Technol.* 52, 1028–1035.
- Bazemore, D.E., Eshleman, K.N., Hollenbeck, K.J., 1994. The role of soil water in stormflow generation in a forested headwater catchment: synthesis of natural tracer and hydrometric evidence. *J. Hydrol.* 162, 47–75.
- Beck, H.E., Albert, I.J.M., van Dijk, D.G., Miralles, R.A.M., de Jeu, L.A., Bruijnzeel, et al., 2013. Global patterns in base flow index and recession based on streamflow observations from 3394 catchments. *Water Resour. Res.* 49, 7843–7863.
- Bell, V.A., Naden, P.S., Tipping, E., Davies, H.N., Carnell, E., Davies, J.A.C., et al., 2021. Long term simulations of macronutrients (C, N and P) in UK freshwaters. *Sci. Total Environ.* 776, 145813.
- Beven, K., Germann, P., 1982. Macropores and water flow in soils. *Water Resour. Res.* 18, 1311–1325.
- Buckingham, S., 2008. Dissolved organic carbon in topsoils: concentration, flux and isotopic composition. PhD Thesis Lancaster University.
- Buckingham, S., Tipping, E., Hamilton-Taylor, J., 2008. Concentrations and fluxes of dissolved organic carbon in UK topsoils. *Sci. Total Environ.* 407, 460–470.
- Butman, D., Raymond, P.A., Butler, K., Aiken, G., 2012. Relationships between $\Delta^{14}\text{C}$ and the molecular quality of dissolved organic carbon in rivers draining to the coast from the conterminous United States. *Glob. Biogeochem. Cycl.* 26, 1–15.
- Butman, D.E., Wilson, H.F., Barnes, R.T., Xenopoulos, M.A., Raymond, P.A., 2015. Increased mobilization of aged carbon to rivers by human disturbance. *Nature Geosci.* 8, 112–116.
- Camino-Serrano, M., Gielen, B., Luyssaert, S., Ciais, P., Vicca, S., Guenet, B., et al., 2014. Linking variability in soil solution dissolved organic carbon to climate, soil type, and vegetation type. *Glob. Biogeochem. Cycl.* 28, 497–509.
- Carter, H.T., Tipping, E., Koprivnjak, J.-F., Miller, M.P., Cookson, B., Hamilton-Taylor, J., 2012. Freshwater DOM quantity and quality from a two-component model of UV absorbance. *Water Res.* 46, 4532–4542.
- Casas-Ruiz, J.P., Catalán, N., Gómez-Gener, L., von Schiller, D., Obrador, B., Kothawala, D.N., et al., 2017. A tale of pipes and reactors: controls on the in-stream dynamics of dissolved organic matter in rivers. *Limnol. Oceanogr.* 62, S85–S94.
- Creed, I.F., McKnight, D.M., Pellerin, B.A., Green, M.B., Bergamaschi, B.A., Aiken, G.R., et al., 2015. The river as a chemostat: fresh perspectives on dissolved organic matter flowing down the river continuum. *Can. J. Fish. Aquat. Sci.* 72, 1272–1285.
- Easthouse, K.B., Mulder, J., Christophersen, N., Seip, H.P., 1992. Dissolved organic carbon fractions in soil and stream water during variable hydrological conditions at birkenes, Southern Norway. *Water Resour. Res.* 28, 1585–1596.
- Franklin, S.M., Kravchenko, A.N., Vargas, R., Vasilas, B., Fuhrmann, J.J., Jin, Y., 2021. The unexplored role of preferential flow in soil carbon dynamics. *Soil Biol. Biochem.* 161, 108398.
- Hagedorn, F., Schleppli, P., Waldner, P., Flüeler, H., 2000. Export of dissolved organic carbon and nitrogen from gleysol dominated catchments – the significance of water flow paths. *Biogeochemistry* 50, 137–161.
- Hood, E., Gooseff, M.N., Johnson, S.L., 2006. Changes in the character of stream water dissolved organic carbon during flushing in three small watersheds, Oregon. *J. Geophys. Res.* 111, G01007.
- Hornberger, G.M., Benca, K.E., McKnight, D.M., 1994. Hydrological controls on dissolved organic carbon during snowmelt in the Snake River near Montezuma Colorado. *Biogeochemistry* 25, 147–165.
- Huntington, T.G., Roesler, C.S., Aiken, G.R., 2019. Evidence for conservative transport of dissolved organic carbon in major river basins in the Gulf of Maine watershed. *J. Hydrol.* 573, 755–767.
- Joerin, C., Beven, K.J., Iorgulescu, I., Musy, A., 2002. Uncertainty in hydrograph separations based on geochemical mixing models. *J. Hydrol.* 255, 90–106.
- Kaiser, K., Kalbitz, K., 2012. Cycling downwards – dissolved organic matter in soils. *Soil Biol. Biochem.* 52, 29–32.
- Kindler, R., Siemens, J., Kaiser, K., Walmsley, D.C., Bernhofer, C., Buchmann, N., et al., 2011. Dissolved carbon leaching from soil is a crucial component of the net ecosystem carbon balance. *Glob. Chang. Biol.* 17, 1167–1185.
- Kothawala, D.N., Ji, X., Laudon, H., Ågren, A.M., Futter, M.N., Köhler, S.J., Tranvik, L.J., 2015. The relative influence of land cover, hydrology, and in-stream processing on the composition of dissolved organic matter in boreal streams. *J. Geophys. Res. Biogeosci.* 120, 1491–1505.
- Langeveld, J., Bouwman, A.F., van Hoek, W.J., Vilmin, L., Beusen, A.H.W., Mogollón, J.M., Middelburg, J.J., 2020. Estimating dissolved carbon concentrations in global soils: a global database and model. *SN Appl. Sci.* 2, 1626.

- Lauerwald, R., Hartmann, J., Ludwig, W., Moosdorf, N., 2012. Assessing the nonconservative fluvial fluxes of dissolved organic carbon in North America. *J. Geophys. Res.* 117, G01027.
- Ledesma, J.L.J., Kothawala, D.N., Bastviken, P., Maehder, S., Grabs, T., Futter, M.N., 2018. Stream dissolved organic matter composition reflects the riparian zone, not upslope soils in boreal forest headwaters. *Water Resour. Res.* 54, 3896–3912.
- Lee, S.-C., Shin, Y., Jeon, Y.-J., Lee, E.-J., Eom, J.-S., Kim, B., Oh, N.-H., 2021. Optical properties and 14C ages of stream DOM from agricultural and forest watersheds during storms. *Environ. Pollut.* 272, 116412.
- Legendre, P., Legendre, L., 2012. Numerical ecology. Number 24 in developments in environmental modelling, 3rd edition Elsevier, Amsterdam.
- Liu, F., Wang, D., Zhang, B., Huang, J., 2021. Concentration and biodegradability of dissolved organic carbon derived from soils: a global perspective. *Sci. Total Environ.* 754, 142378.
- Marwick, T.R., Tamooh, F., Teodoru, C.R., Borges, A.V., Darchambeau, F., Bouillon, S., 2015. The age of river-transported carbon: a global perspective. *Glob. Biogeochem. Cycl.* 29, 122–137.
- Masiello, C.A., Druffel, E.R.M., 2001. Carbon isotope geochemistry of the Santa Clara River. *Glob. Biogeochem. Cycl.* 15, 407–416.
- Mayorga, E., Aufdenkampe, A.K., Masiello, C.A., Krusche, A.V., Hedges, J.I., Quay, P.D., et al., 2005. Young organic matter as a source of carbon dioxide outgassing from amazonian rivers. *Nature* 436, 538–541.
- Michalzik, B., Tipping, E., Mulder, J., Gallardo Llancho, J.F., Matzner, E., Bryant, C.L., Clarke, N., Lofts, S., Vicente Esteban, M.A., 2003. Modelling the production and transport of dissolved organic carbon in forest soils. *Biogeochemistry* 66, 241–264.
- Mineau, M.M., Wollheim, W.M., Buffam, I., Findlay, S.E.G., Hall, R.O., Hotchkiss, E.R., et al., 2016. Dissolved organic carbon uptake in streams: a review and assessment of reach-scale measurements. *J. Geophys. Res. Biogeosci.* 121, 2019–2029.
- Moore, T.R., Clarkson, B.R., 2007. Dissolved organic carbon in New Zealand peatlands. *New Zealand J. Marine Freshwat. Res.* 41, 137–141.
- Mulder, J., Gallardo Llancho, J.F., Matzner, E., Tipping, E., Bryant, C., Clarke, N., et al., 2000. Effects of natural climatic variations on production and transport of dissolved organic matter in European forest ecosystems. PROTOS (EU) Project Final Report.
- Naden, P., Bell, V., Carnell, E., Tomlinson, S., Dragosits, U., Chaplow, J., et al., 2016. Nutrient fluxes from domestic wastewater: a national-scale historical perspective for the UK 1800–2010. *Sci. Total Environ.* 572, 1471–1484.
- Nakhavali, M., Lauerwald, R., Regnier, P., Guenet, B., Chadburn, S., Friedlingstein, P., 2021. Leaching of dissolved organic carbon from mineral soils plays a significant role in the terrestrial carbon balance. *Glob. Chang. Biol.* 27, 1083–1096.
- Neff, J.C., Asner, G.P., 2001. Dissolved organic carbon in terrestrial ecosystems: synthesis and a model. *Ecosystems* 4, 29–48.
- Neff, J.C., Finlay, J.C., Zimov, S.A., Davydov, S.P., Carrasco, J.J., Schuur, E.A.G., Davydova, A.I., 2006. Seasonal changes in the age and structure of dissolved organic carbon in Siberian rivers and streams. *Geophys. Res. Lett.* 33, L23401.
- O'Donnell, J.A., Aiken, G.R., Kane, E.S., Jones, J.B., 2010. Source water controls on the character and origin of dissolved organic matter in streams of the Yukon River basin Alaska. *J. Geophys. Res.* 115, G03025.
- Peel, M.C., Finlayson, B.L., McMahon, T.A., 2007. Updated world map of the Köppen-Geiger climate classification. *Hydrol. Earth Syst. Sci.* 11, 1633–1644.
- Poulin, B.A., Ryan, J.N., Aiken, G.R., 2014. Effects of iron on optical properties of dissolved organic matter. *Environ. Sci. Technol.* 48, 10098–10106.
- Pschenyckyj, C.M., Clark, J.M., Shaw, L.J., Griffiths, R.I., Evans, C.D., 2020. Effects of acidity on dissolved organic carbon in organic soil extracts, pore water and surface litters. *Sci. Total Environ.* 703, 135585.
- Qualls, R.G., Haines, B.L., 1991. Geochemistry of dissolved organic nutrients in water percolating through a forest ecosystem. *Soil Sci. Soc. Am. J.* 55, 1112–1123.
- Qualls, R.G., Haines, B.L., 1992. Biodegradability of dissolved organic matter in forest throughfall, soil solution, and stream water. *Soil Sci. Soc. Am. J.* 56, 578–586.
- R Core Team, 2017. R: A language and environment for statistical computing. R Foundation for Statistical Computing, Vienna, Austria. <https://www.R-project.org/>.
- Raymond, P.A., Spencer, R.G.M., 2015. Riverine DOM. In: Hansell, D.A., Carlson, C.A. (Eds.), *Biogeochemistry of Marine Dissolved Organic Matter*, Chapter 11. Elsevier, Amsterdam, pp. 509–533.
- Regan, S., Hynds, P., Flynn, R., 2017. An overview of dissolved organic carbon in groundwater and implications for drinking water safety. *Hydrogeol. J.* 25, 959–967.
- Ripszám, M., Paczkowska, Figueira, Veenaas, C., Haglund, P., 2015. Dissolved organic carbon quality and sorption of organic pollutants in the Baltic Sea in light of future climate change. *Environ. Sci. Technol.* 49, 1445–1452.
- Sanderman, J., Baldock, J.A., Amundson, R., 2008. Dissolved organic carbon chemistry and dynamics in contrasting forest and grassland soils. *Biogeochemistry* 89, 181–198.
- Sanderman, J., Lohse, K.A., Baldock, J.A., Amundson, R., 2009. Linking soils and streams: sources and chemistry of dissolved organic matter in a small coastal watershed. *Water Resour. Res.* 45, W03418.
- Schulze, K., Borken, Matzner, W.E., 2011. Dynamics of dissolved organic 14C in throughfall and soil solution of a Norway spruce forest. *Biogeochemistry* 106, 461–473.
- Scott, M.J., 1998. Temporal patterns in the chemistry, flux and molecular characteristics of dissolved organic carbon in drainage water from an upland peat system. PhD Thesis University of Manchester.
- Spencer, R.G.M., Aiken, G.R., Domblaser, M.M., Butler, K.D., Holmes, R.M., Fiske, G.P., Mann, J., Stubbins, A., 2013. Chromophoric dissolved organic matter export from U.S. Rivers. *Geophys. Res. Lett.* 40, 1575–1579.
- Tipping, E., Rowe, E.C., 2019. Modelling the physical states, element stoichiometries and residence times of topsoil organic matter. *Eur. J. Soil Sci.* 70, 321–337.
- Tipping, E., Chamberlain, P.M., Fröberg, M., Hanson, P.J., Jardine, P.M., 2012. Simulation of carbon cycling, including dissolved organic carbon transport, in forest soil locally enriched with 14C. *Biogeochem.* 108, 91–107.
- Tiwari, T., Laudon, H., Beven, K., Ågren, A.M., 2014. Downstream changes in DOC: inferring contributions in the face of model uncertainties. *Water Resour. Res.* 50, 514–525.
- Van Gaalen, N., Verheyen, D., Ronchi, B., Struyf, E., Govers, G., Vanderborght, G., Diels, J., 2014. Identifying the transport pathways of dissolved organic carbon in contrasting catchments. *Vadose Zone J.* 13 vzj2013.11.0199.
- Van Verseveld, W.J., McDonnell, J.J., Lajtha, K., 2008. A mechanistic assessment of nutrient flushing at the catchment scale. *J. Hydrol.* 358, 268–287.
- Ward, N.D., Bianchi, T.S., Medeiros, P.M., Seidel, M., Richey, J.E., Keil, R.G., Sawakuchi, H.O., 2017. Where carbon goes when water flows: carbon cycling across the aquatic continuum. *Front. Mar. Sci.* 4, 7.
- Weishaar, J.L., Aiken, G.R., Bergamschi, B.R., Fram, M.S., Fujii, R., Mopper, K., 2003. Evaluation of specific ultraviolet absorbance as an indicator of the chemical composition and reactivity of dissolved organic carbon. *Environ. Sci. Technol.* 37, 4702–4708.
- Williamson, J.L., Tye, A., Lapworth, D.J., Monteith, D., Sanders, R., Mayor, D.J., et al., 2021. Landscape controls on riverine export of dissolved organic carbon from Great Britain. *Biogeochemistry* <https://doi.org/10.1007/s10533-021-00762-2>.
- Wilson, H.F., Raymond, P.A., Saiers, J.E., Sobczak, W.V., Xu, N., 2016. Increases in humic and bioavailable dissolved organic matter in a forested New England headwater stream with increasing discharge. *Mar. Freshwat. Res.* 67, 1279–1292.
- Wollheim, W.M., Stewart, R.J., Aiken, G.R., Butler, K.D., Morse, N.B., Salisbury, J., 2015. Removal of terrestrial DOC in aquatic ecosystems of a temperate river network. *Geophys. Res. Lett.* 42, 6671–6679.